

P/N: FAPE300824

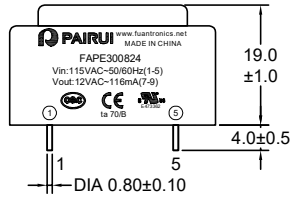

Outline Dimensions(Unit:mm)



Front View

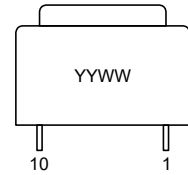

Side View



Bottom View



Top View

Note:

1.Remove Pins 2,3,4,6,8,10.

Wave Soldering

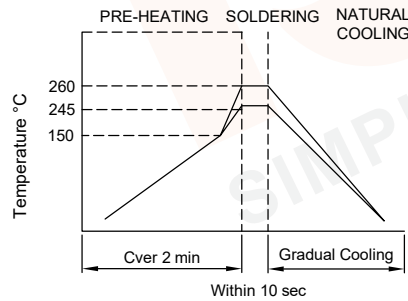

Note:
1.Never Contact the ceramic with the iron tip;
2.1.0mm tip diameter(max).

Electronical Schematic

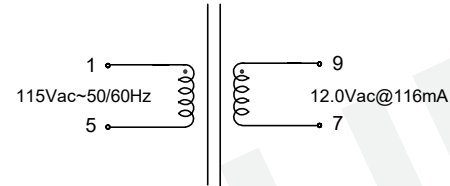

Electrical Characteristics

Input 115Vac 60Hz to 1-5 :
Excitation current(Ix):10mA Max.
Output: Vo=21.0Vac Typ(No-load).
VL=12.0Vac±5%(@116mA).
Insulation Resistance: Pri-Sec:100 Mohms Min @500V.
Hi-Pot: Pri-Sec:4000VAC/5mA/60Second.

General Properties

Operating Temperature:-25°C to +70°C.
Storage Temperature:-25°C to +85°C.
Insulation Class: B.

REV	DESCRIPTION	APPD	DATE	Tianchang Fuan Electronic Co Ltd www.fuantronics.net TEL: +86-550-7814888 FAX: +86-550-7831133	 Tolerances unless otherwise specified: (X)±0.50 (XX)±0.25 Unit of measurement: mm	Make: Qiumei.Liu Checked: Beson. zhan Approved: Anson. zhan	DRAWING TITLE 1.40W Encapsulated Transformer For EI30*8,115VAC Input 50/60Hz Material Number:	Customer Name:
								Document/Rev: 00
								Specification Sheet: 1 of 3
								Date of Recognition: May./05/2022

P/N: FAPE300824



List of UL Certificate:

No.	Part Name	Mat'l Description	Supplier	UL Number
1	Bobbin	EI30*8/PBT(Black)	Chang Chun Plastics Co Ltd	E59481
2	Case	CASE-EI30*8/PA66(Orange)	Zhejiang Juner New Materials Co Ltd	E204321
3	Copper wire	xUEW/180/MW 82-C	JiangSu Dartong M & E Co Ltd	E237377
4	Core	Lamination	Ta Yea Steel Industry Co Ltd	N/A
5	Epoxy	PU552(Black)	Wevo-Chemle Gmbh	E108835
6				

Packaging Specification:

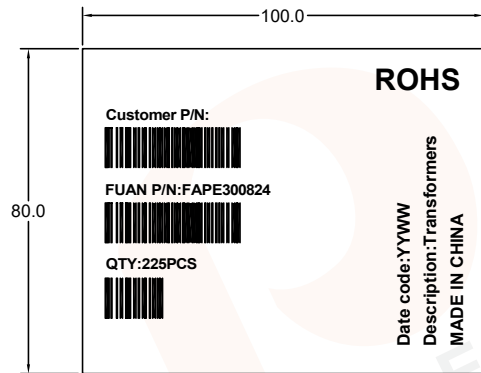

Label of outer

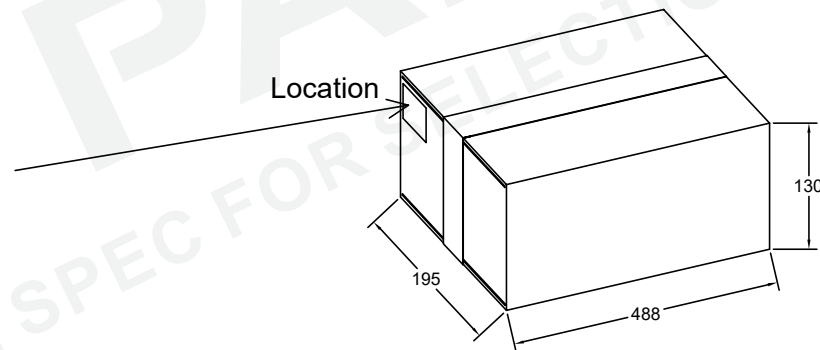

put the label on the top left corner of one of the carton sides

				Tianchang Fuan Electronic Co Ltd www.fuantronics.net TEL: +86-550-7814888 FAX: +86-550-7831133	 Tolerances unless otherwise specified: (.X)±0.50 (XX)±0.25 Unit of measurement: mm	Make: Qiumei.Liu Checked: Beson. zhan Approved: Anson. zhan	DRAWING TITLE 1.40W Encapsulated Transformer For EI30*8,115VAC Input 50/60Hz Material Number:	Customer Name: Document/Rev: 00 Specification Sheet: 2 of 3 Date of Recognition: May./05/2022
REV	DESCRIPTION	APPD	DATE					

P/N: FAPE300824

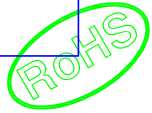

Packing Method:

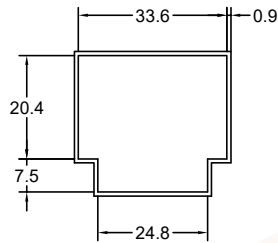
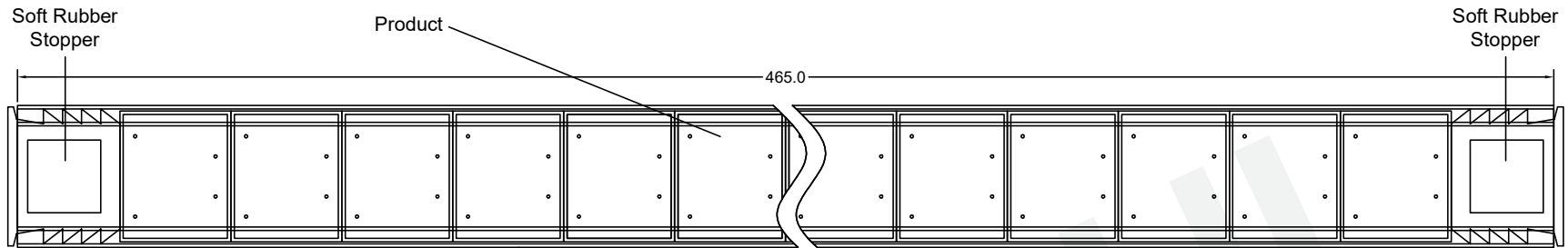

Size of packaging tube:
465mm*35.4mm*32.7mm
(Length * Width * Height)

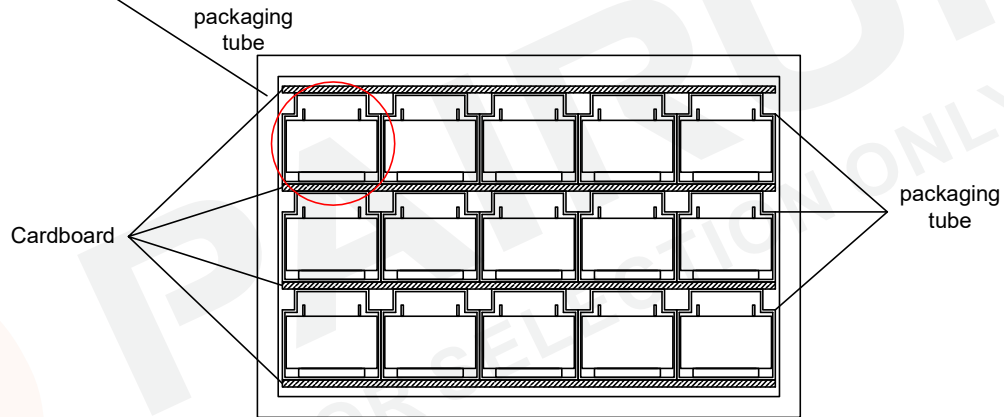

Carton Box Side View

Layer/Carton	Quantity/Tube (pcs)	Quantity/Carton (pcs)	Net weight (g/pc)	Gross weight (g/tube)	Tubes/carton (pcs)	Total weight (kg)	box size Dimensions (mm)
3.0	15.0	225.0	60.0	94.56	15.00	17.80	488*195*130

REV	DESCRIPTION	APPD	DATE

Tianchang Fuan Electronic Co Ltd
www.fuantronics.net
TEL: +86-550-7814888
FAX: +86-550-7831133



Tolerances unless otherwise specified:
(.X)±0.50 (XX)±0.25
Unit of measurement: mm

Make: Qiumei.Liu
Checked: Beson. zhan
Approved: Anson. zhan

DRAWING TITLE
1.40W Encapsulated Transformer
For EI30*8,115VAC Input 50/60Hz
Material Number:

Customer Name:
Document/Rev: 00
Specification Sheet: 3 of 3
Date of Recognition: May./05/2022